

# Schreibers Garten

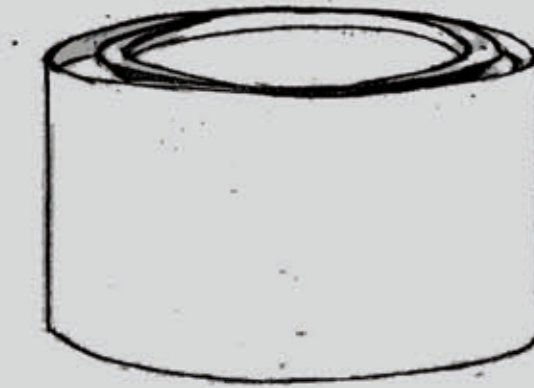

Holzlasur für außen (HL)  
Tafellack (TL)

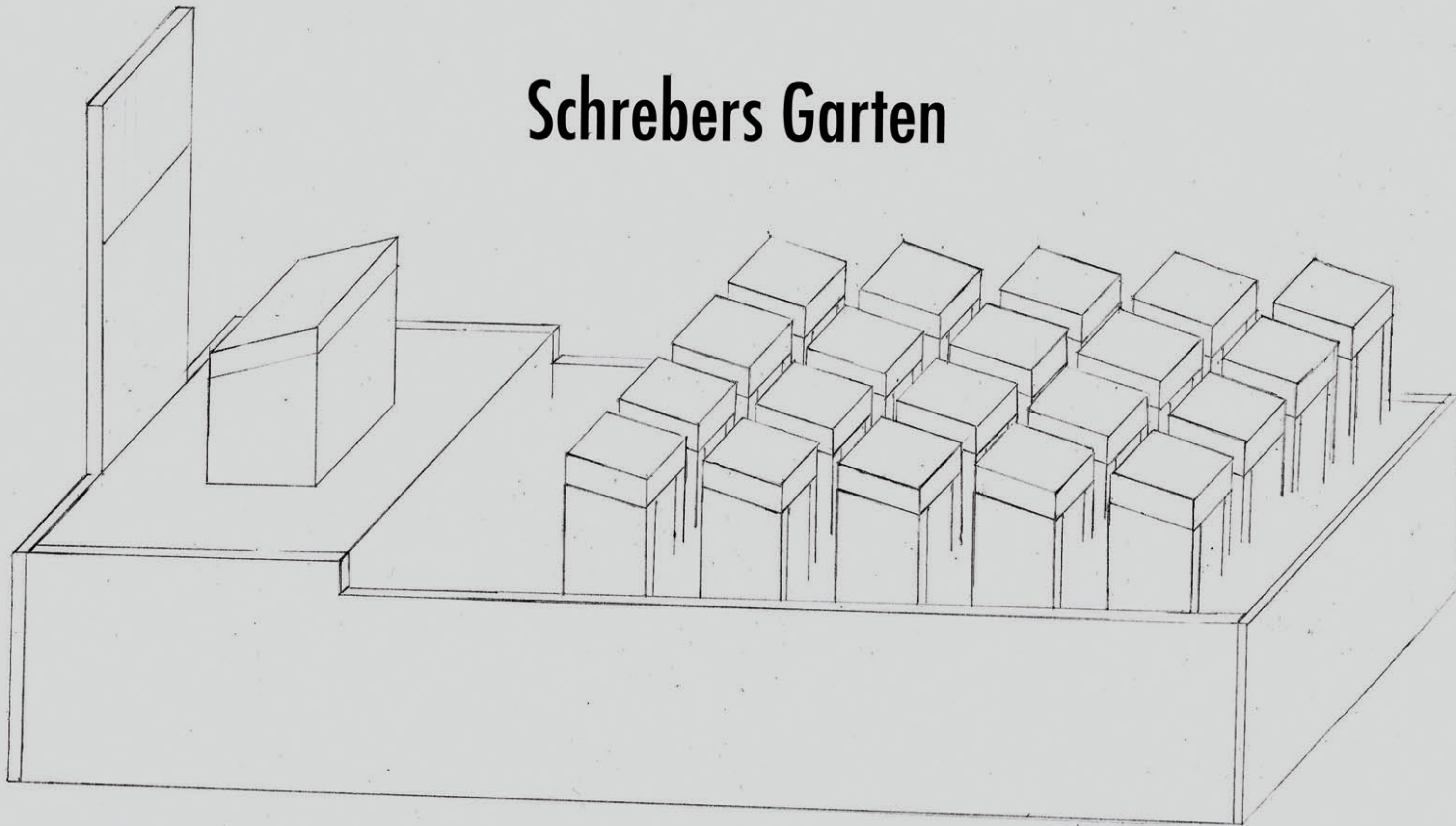
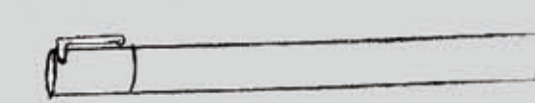

schwarzer Edding

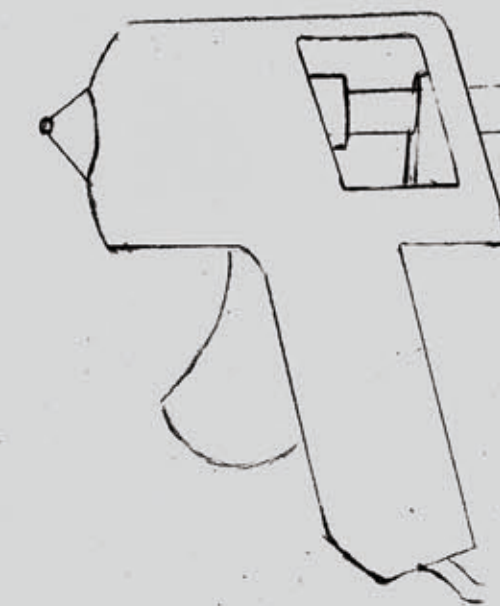

Heißeimpistole

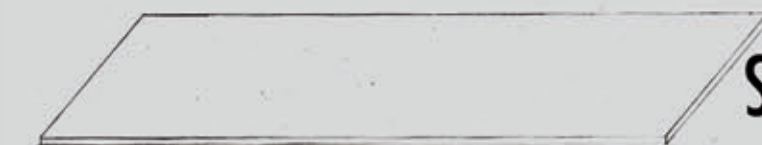

Sperholz 8mm dick

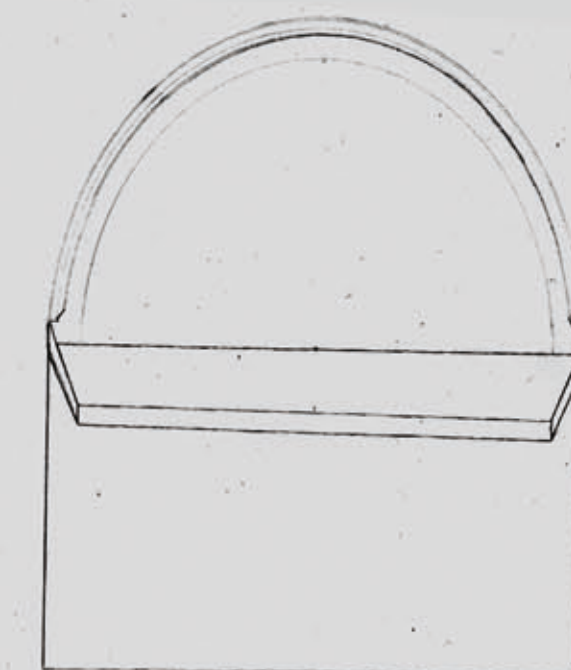

Tellerschleifgerät

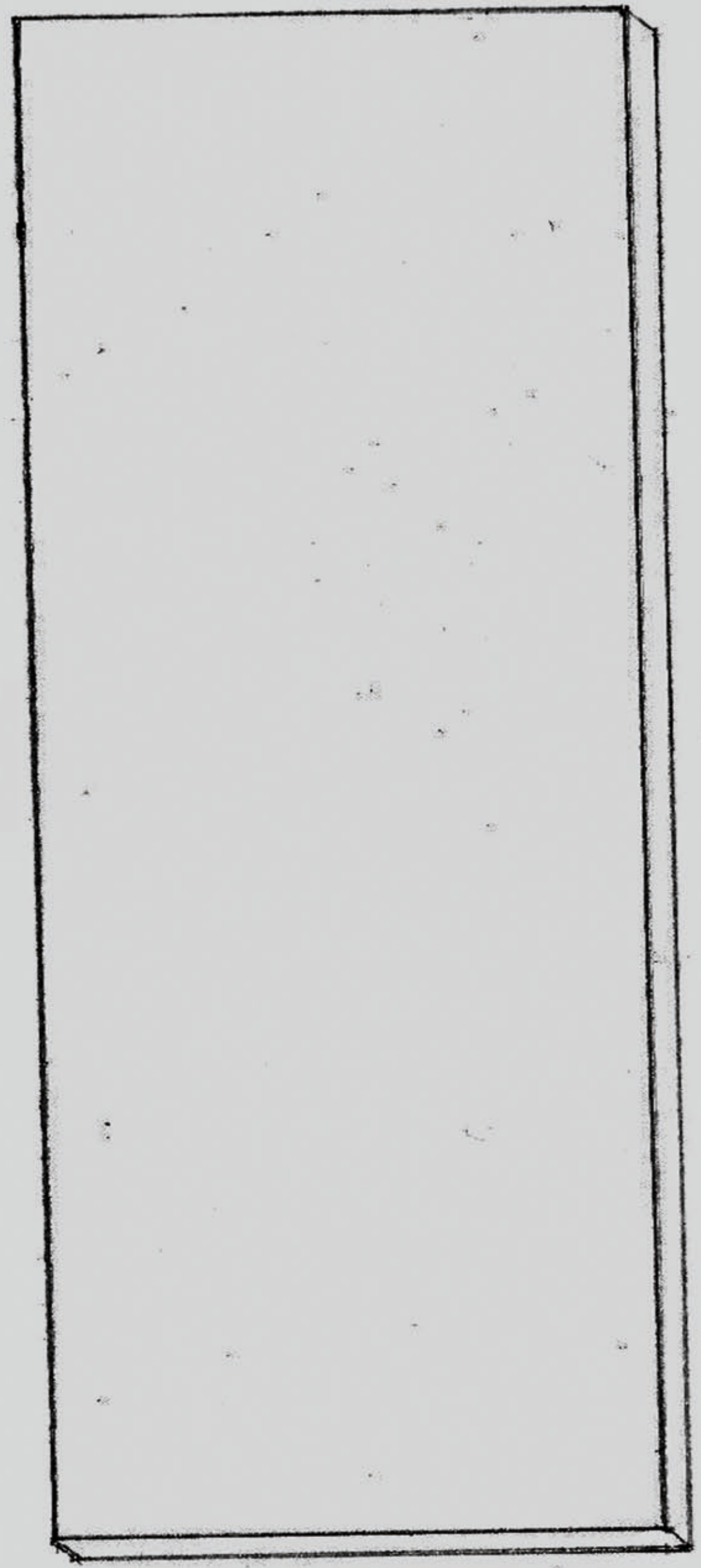
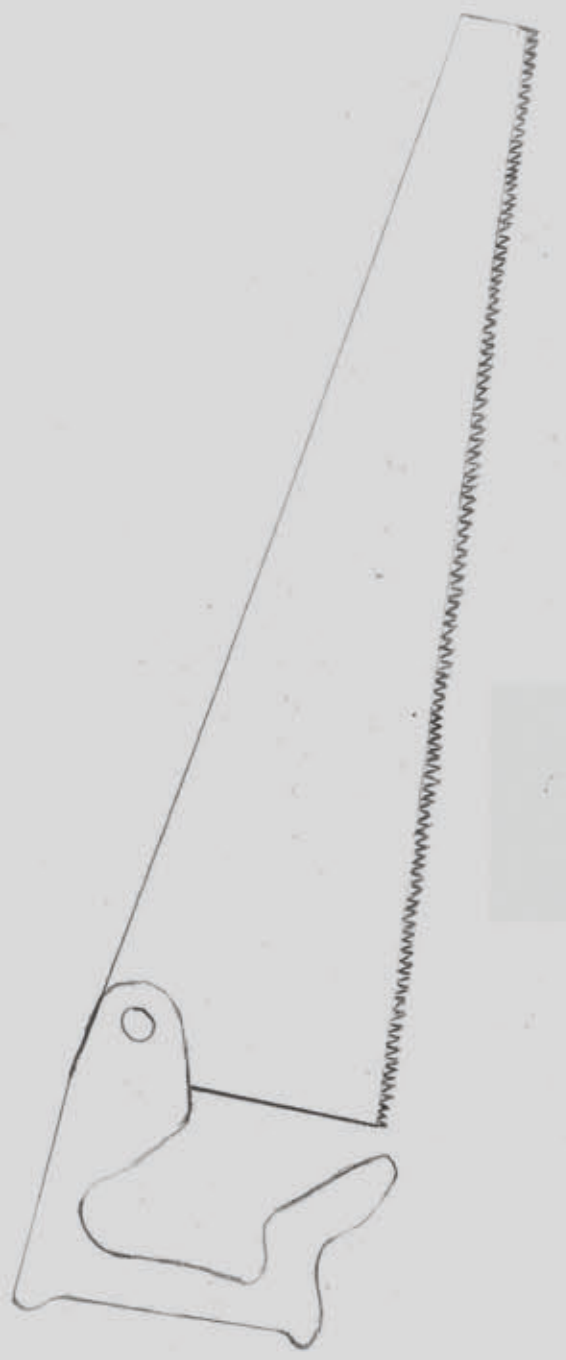

**B' 20x**

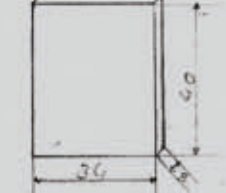

**D 40x**



**C' 1x**

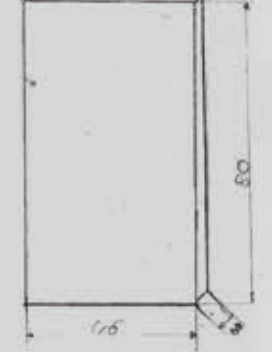

**A' 1x**

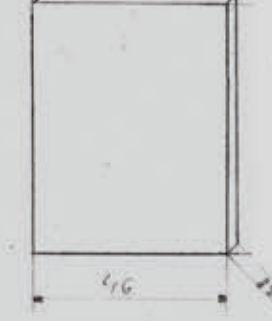

**E 2x**

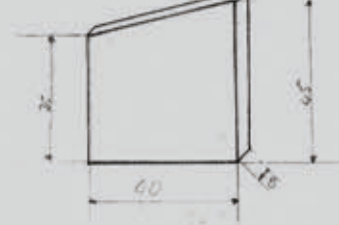

**J 1x**

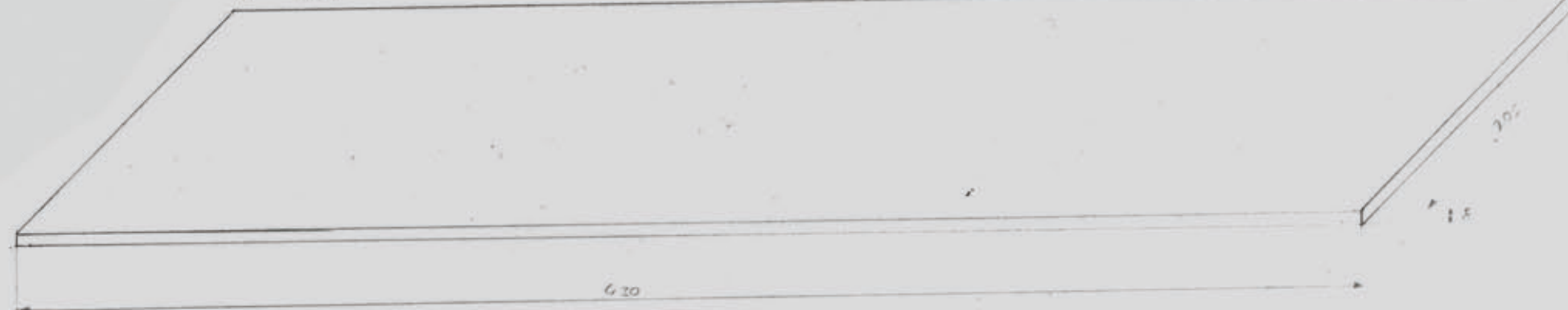

**H 1x**

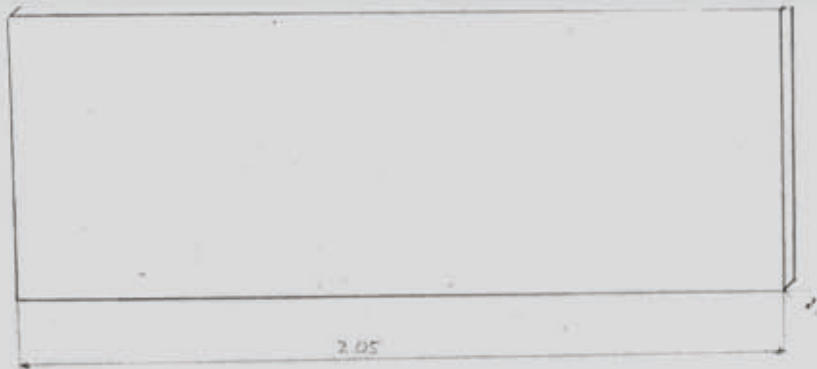

**G 1x**

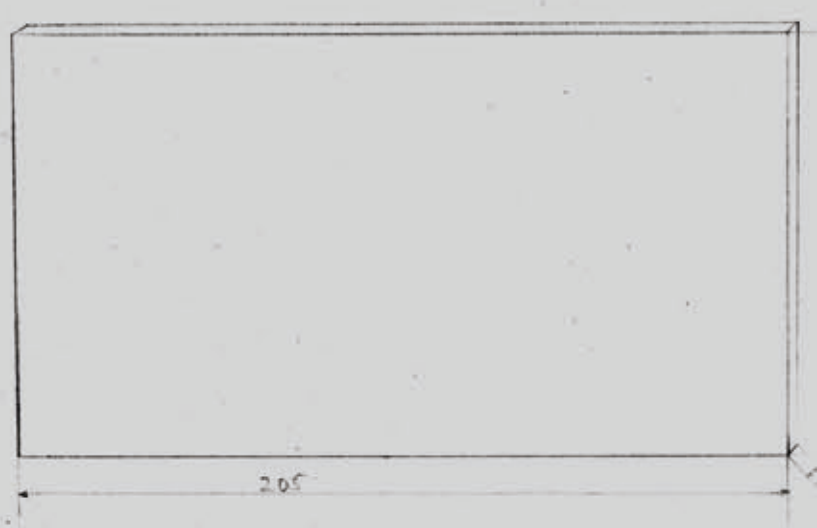

**F 2x**

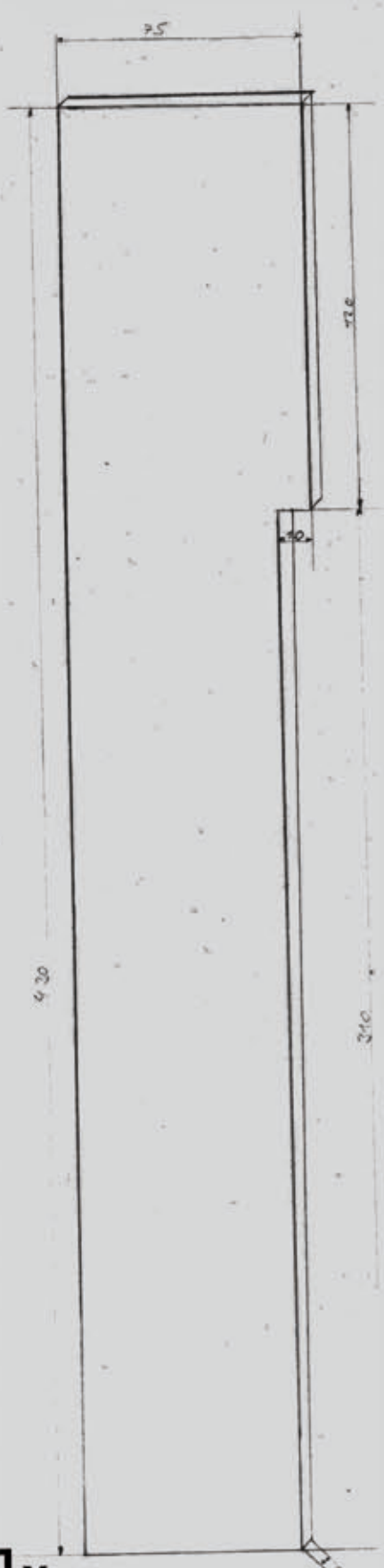

**K 1x**

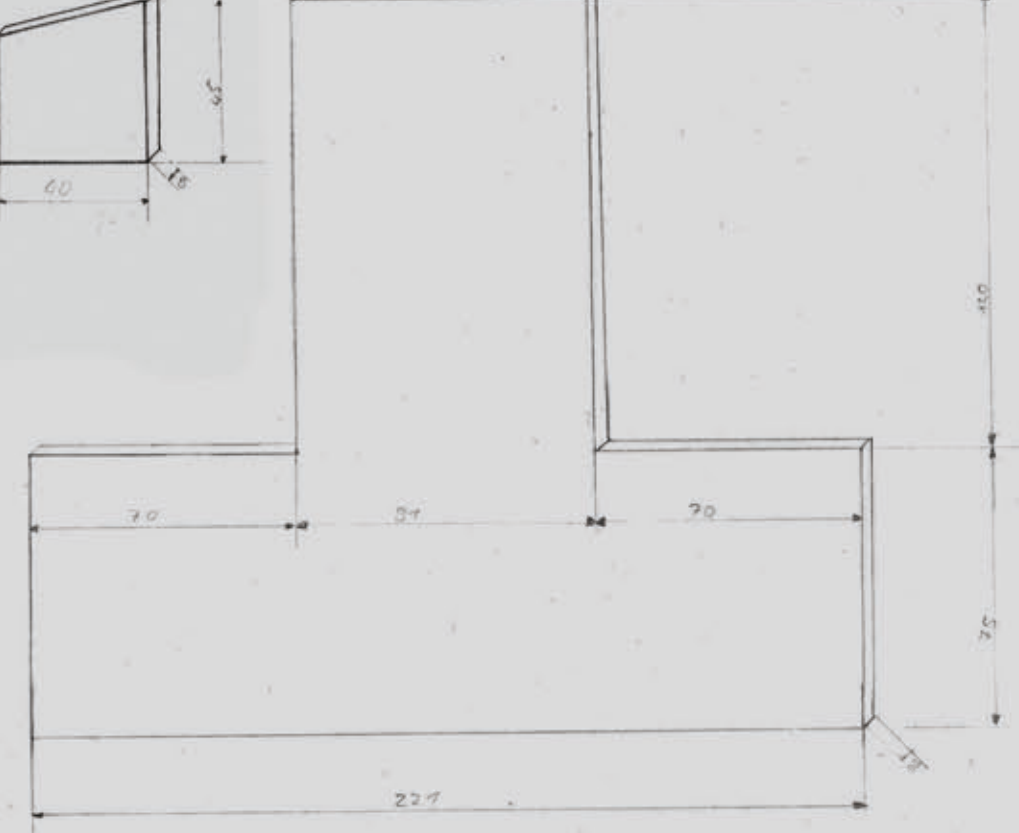

**I 1x**

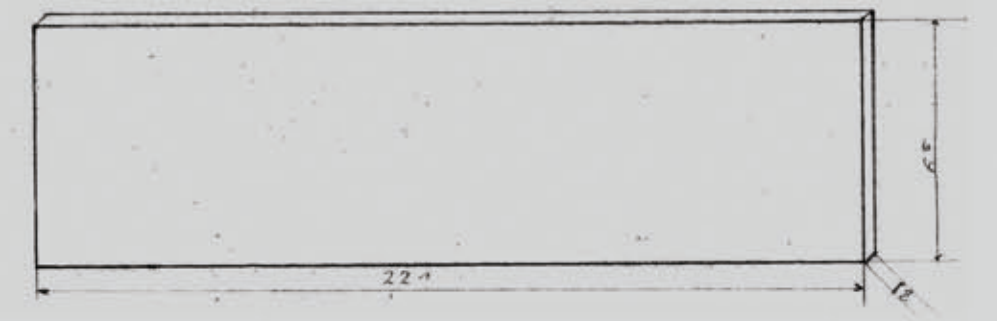

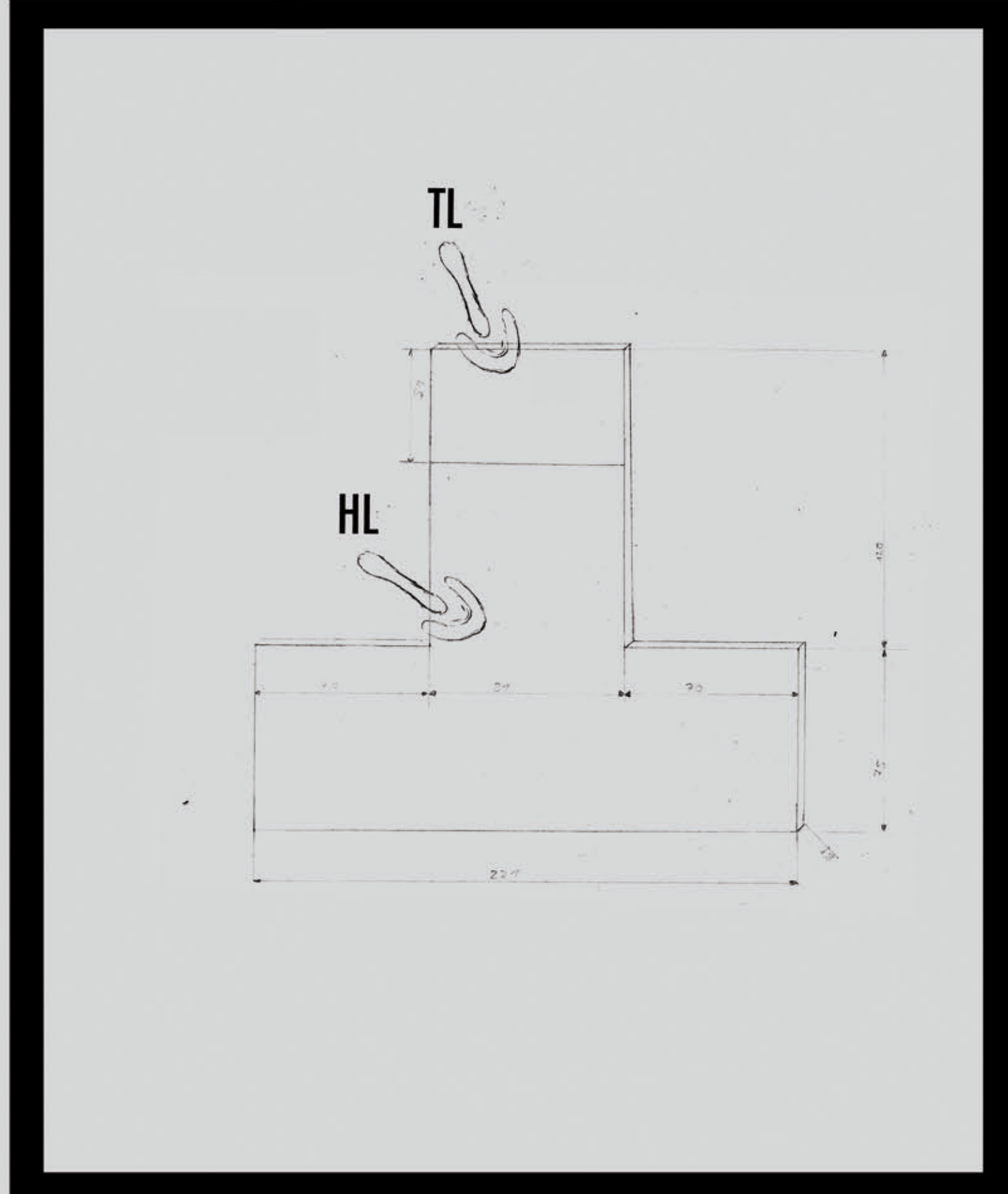
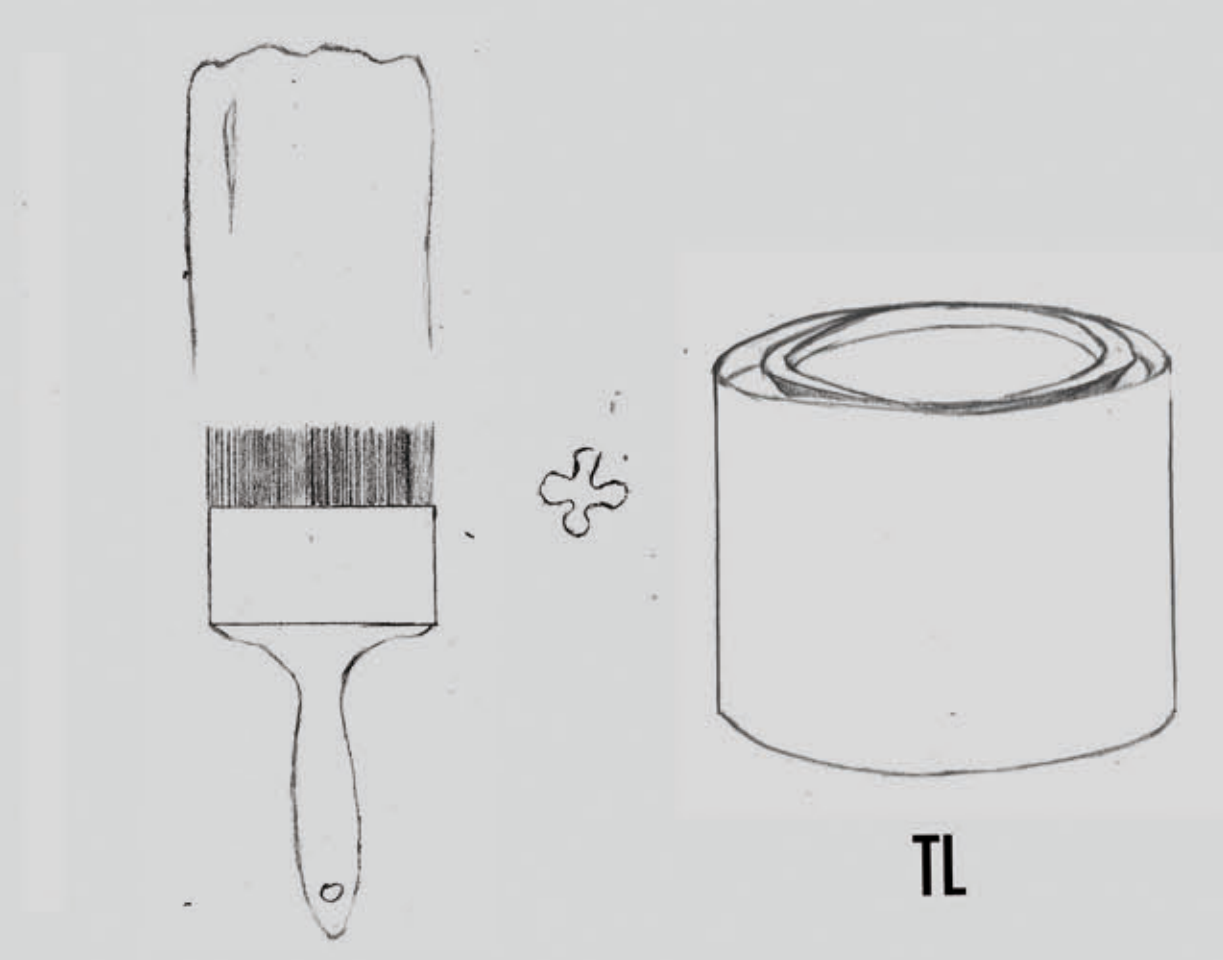
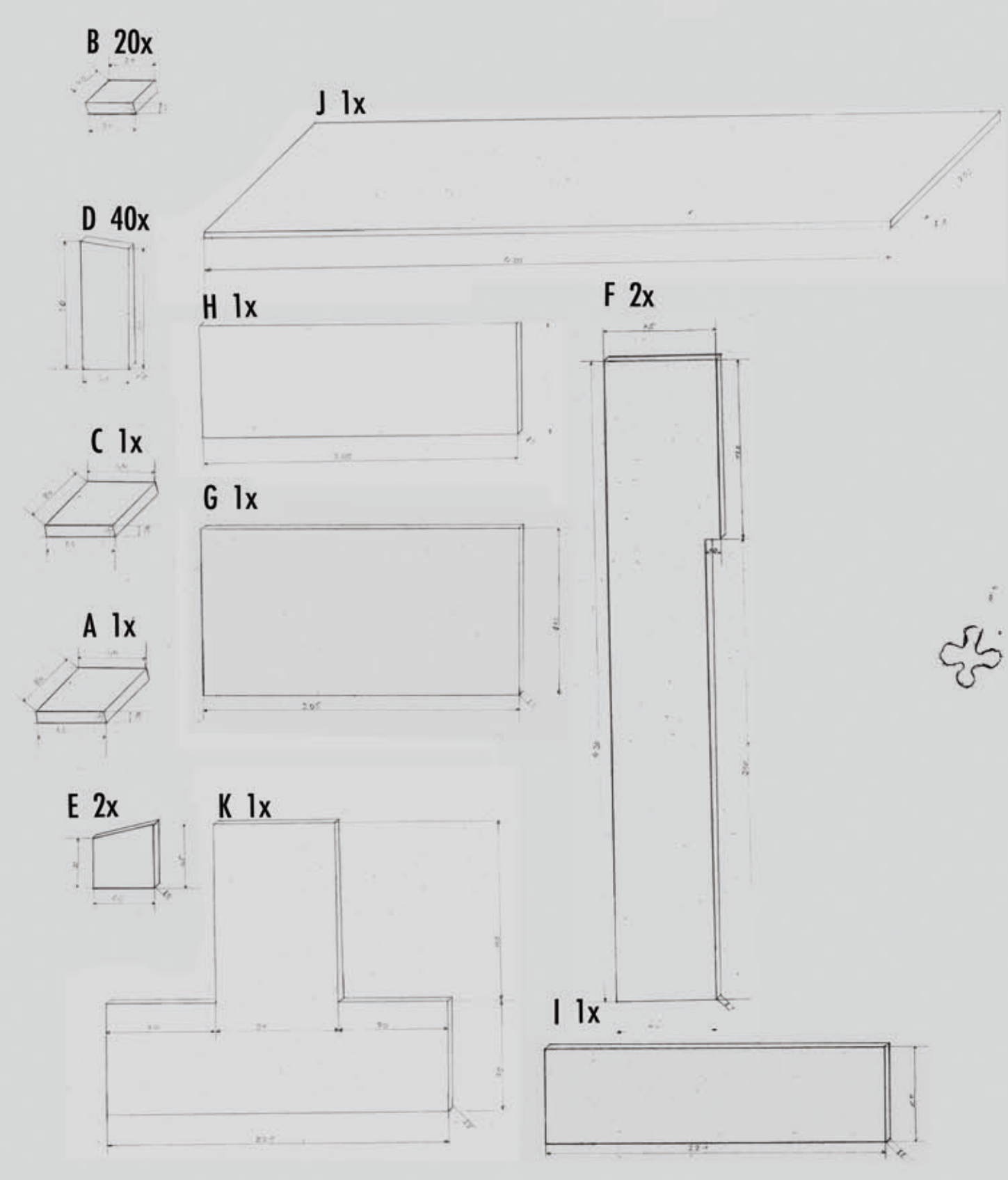
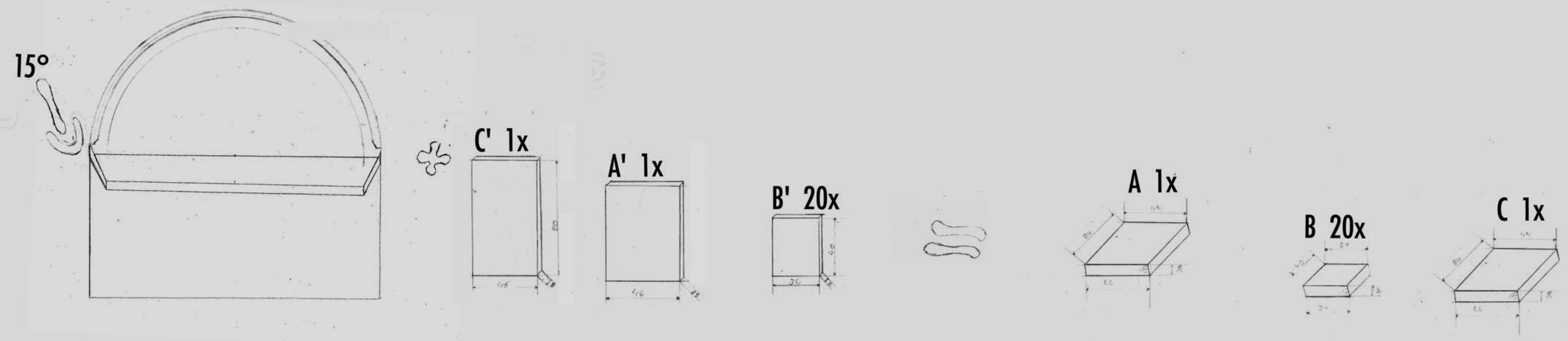

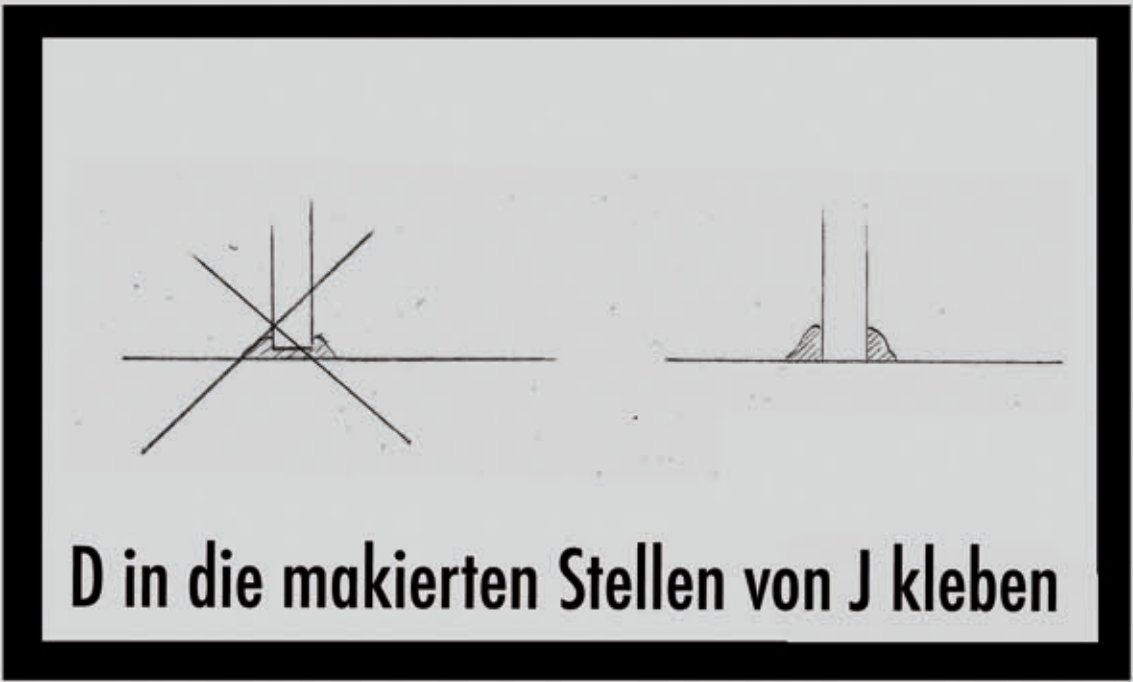
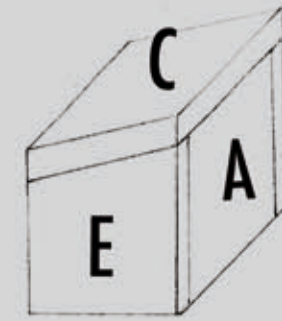
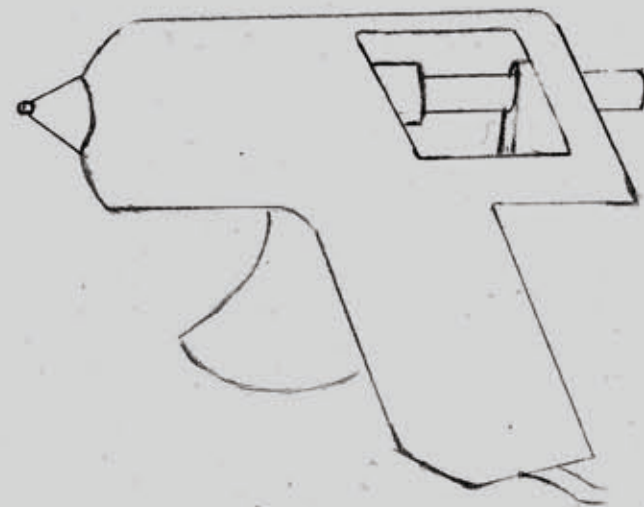
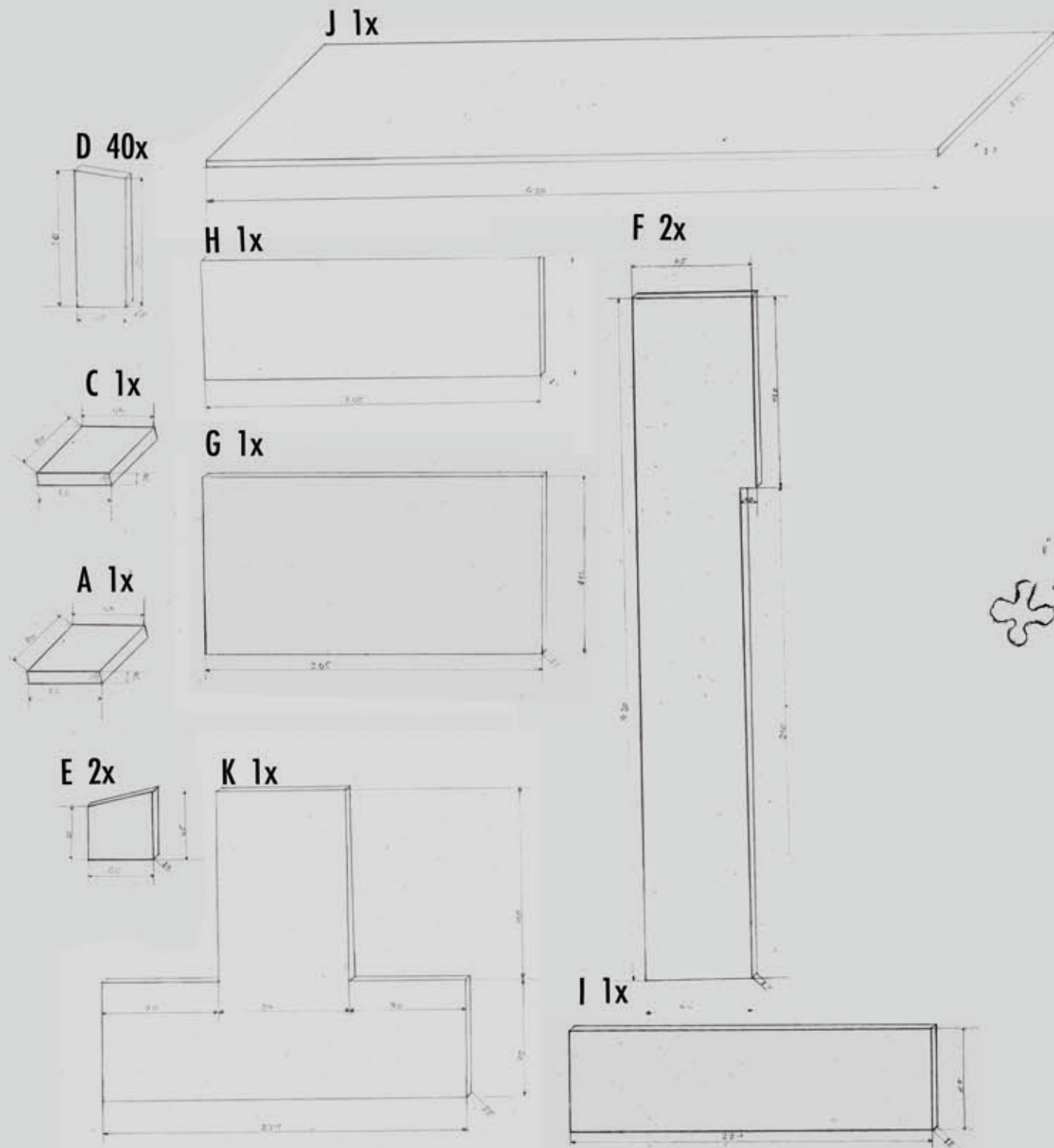
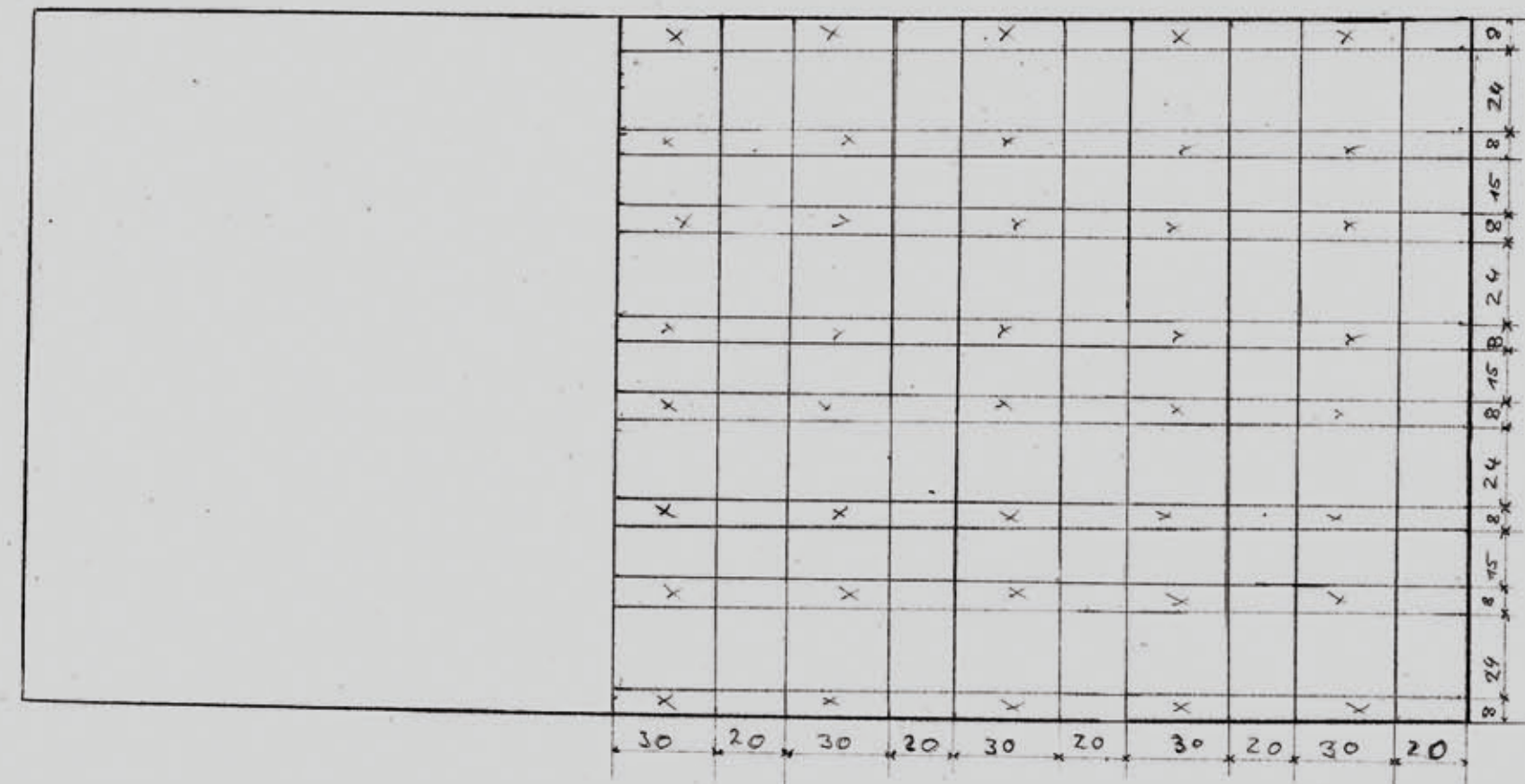
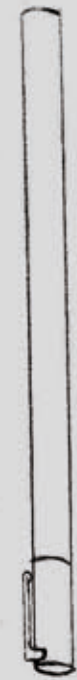
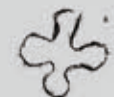
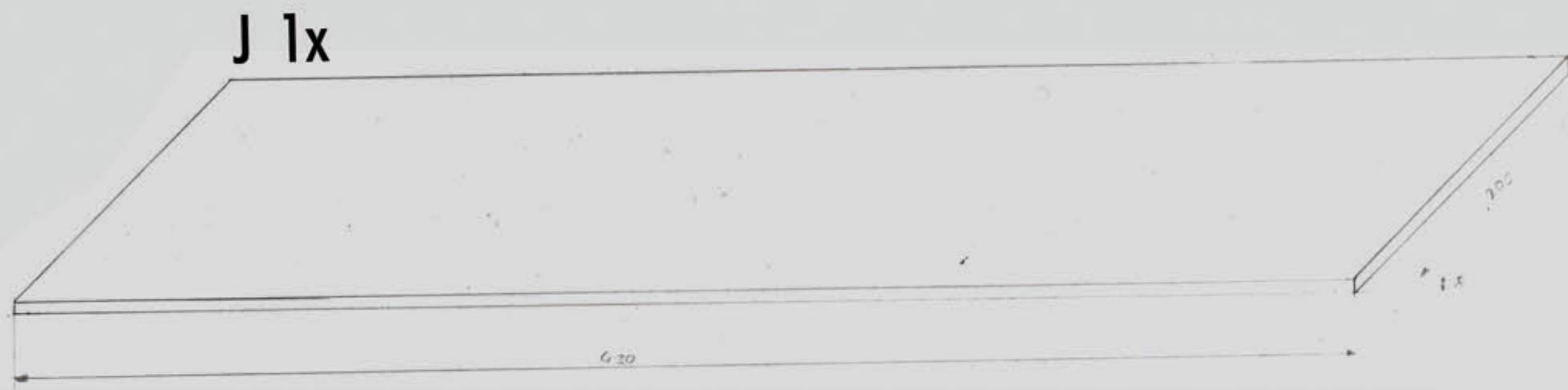

**D in die markierten Stellen von J kleben**

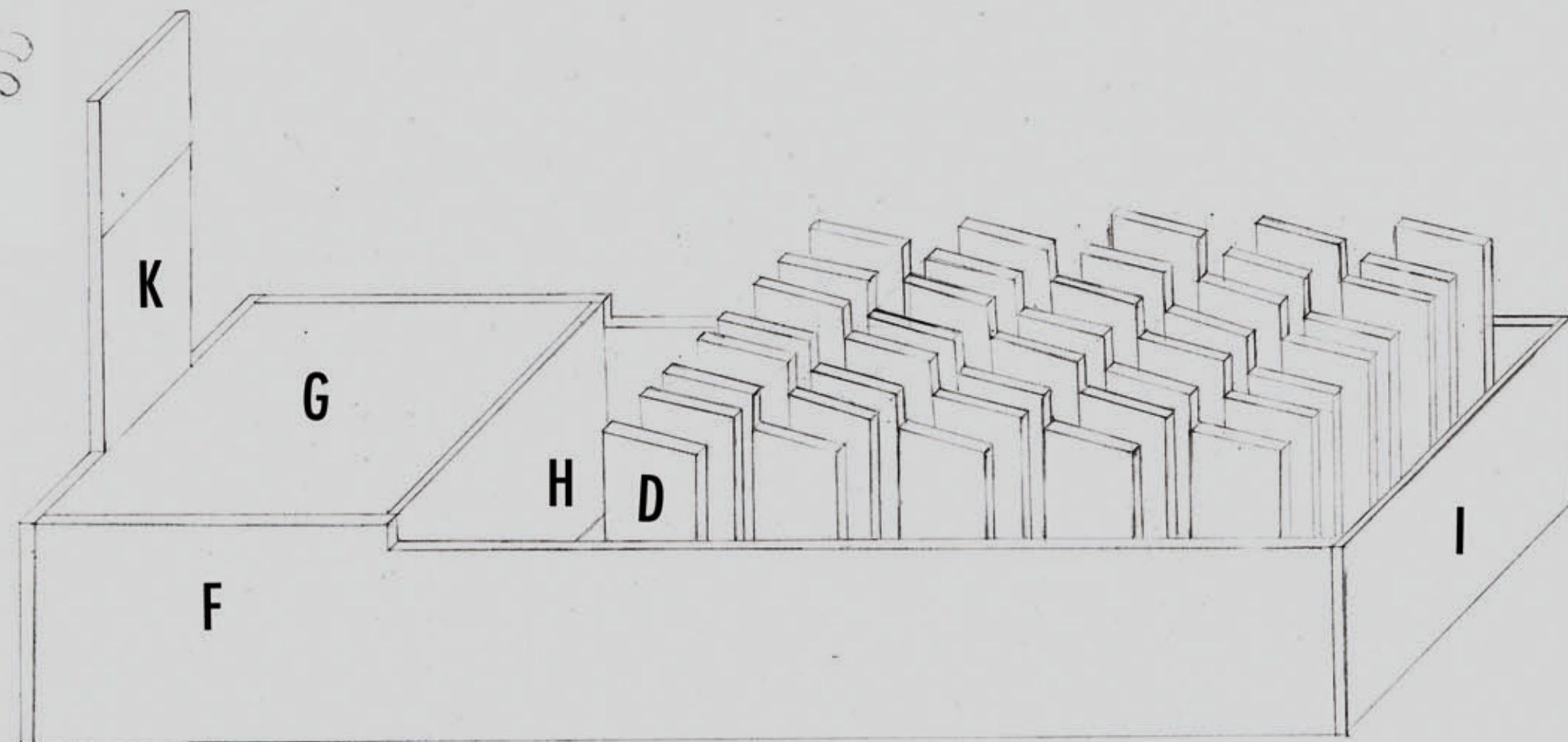

Erde

